

Double-Acting Hollow Cylinders - DHC series

Doc. : L1076A Date : 2018/12

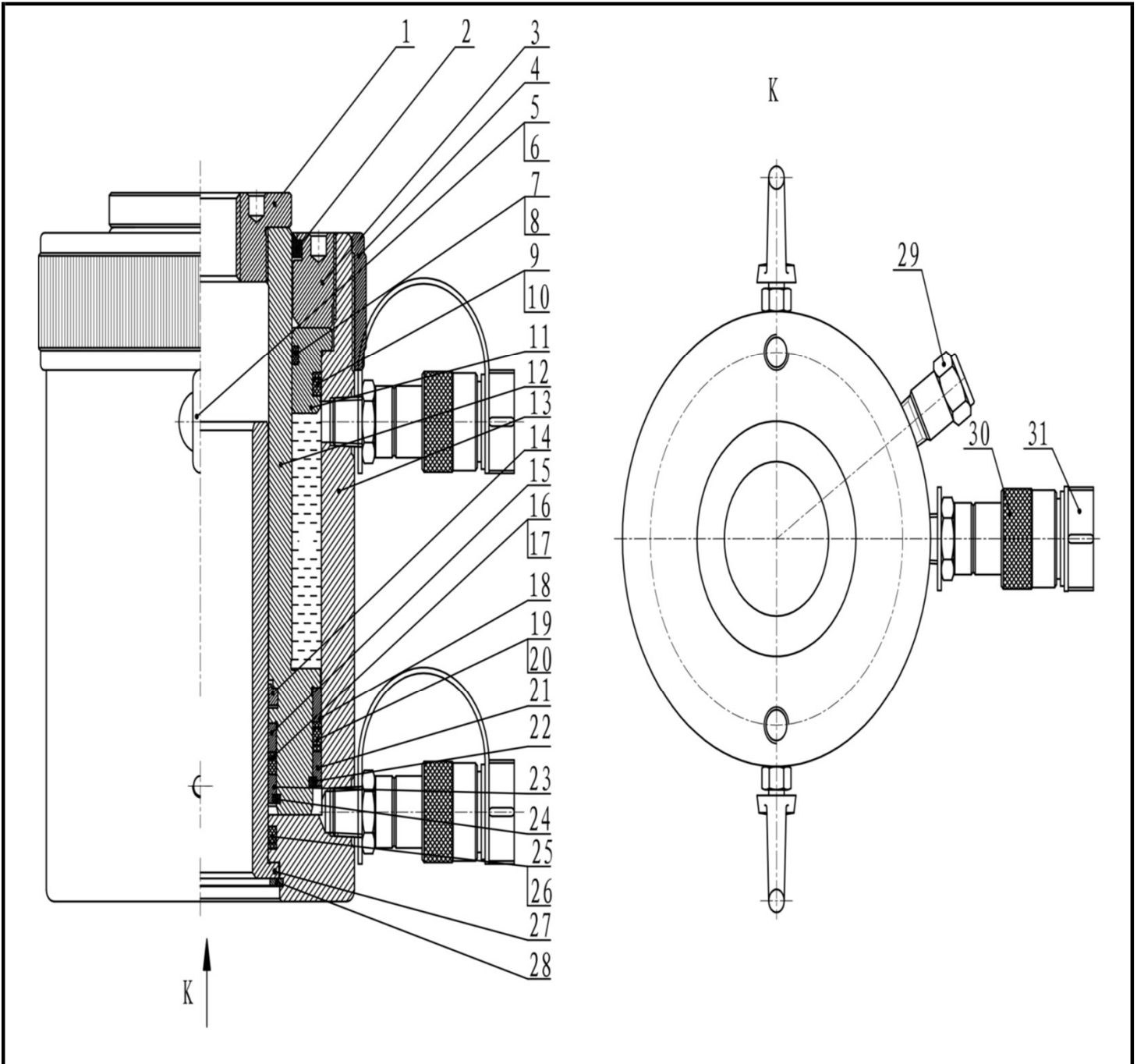

Item NO.	Description	Qty	Part NO.
			DHC 1000-257
1	Lifting head	1	2.001.02143
2	J-dustband	1	●
3	Guide cap	1	2.001.02891
4	Thread protector	1	2.001.02145
5	Lifting bolt (Item #6 included)	2	1.3.009.00005
6	Hexagon nut	2	-
7	Backup Washer	1	●
8	O- ring	1	●
9	Backup Washer	1	●
10	O- ring	1	●
11	Front guide ring	1	2.001.02892
12	Piston rod	1	2.001.03278
13	Oil cylinder	1	2.001.03277
14	J-dustband	1	●
15	Front the inner guide ring	1	2.001.03281
16	Backup Washer	1	●
17	O- ring	1	●
18	Front guide sleeve	1	2.001.03279
19	Backup Washer	2	●
20	O- ring	1	●
21	Back the guide sleeve	1	2.001.03280
22	Semi-ring	1	2.001.02898
23	Back the inner guide sleeve	1	2.001.03282
24	Inner semi-ring	1	2.001.02900
25	Backup Washer	1	●
26	O- ring	1	●
27	Centre hole	1	2.001.03283
28	Circlips for holes	1	●
29	Safety valve	1	2.008.00047
30	Female connector	2	1.3.025.00004
31	Connector protective jacket for NPT3/8"	2	1.3.097.00002
●	Repair kit	1	DHC 1000-RK