

Single-Acting Low Flat Cylinders - SLC

Doc. : L1021A Date : 2019/01

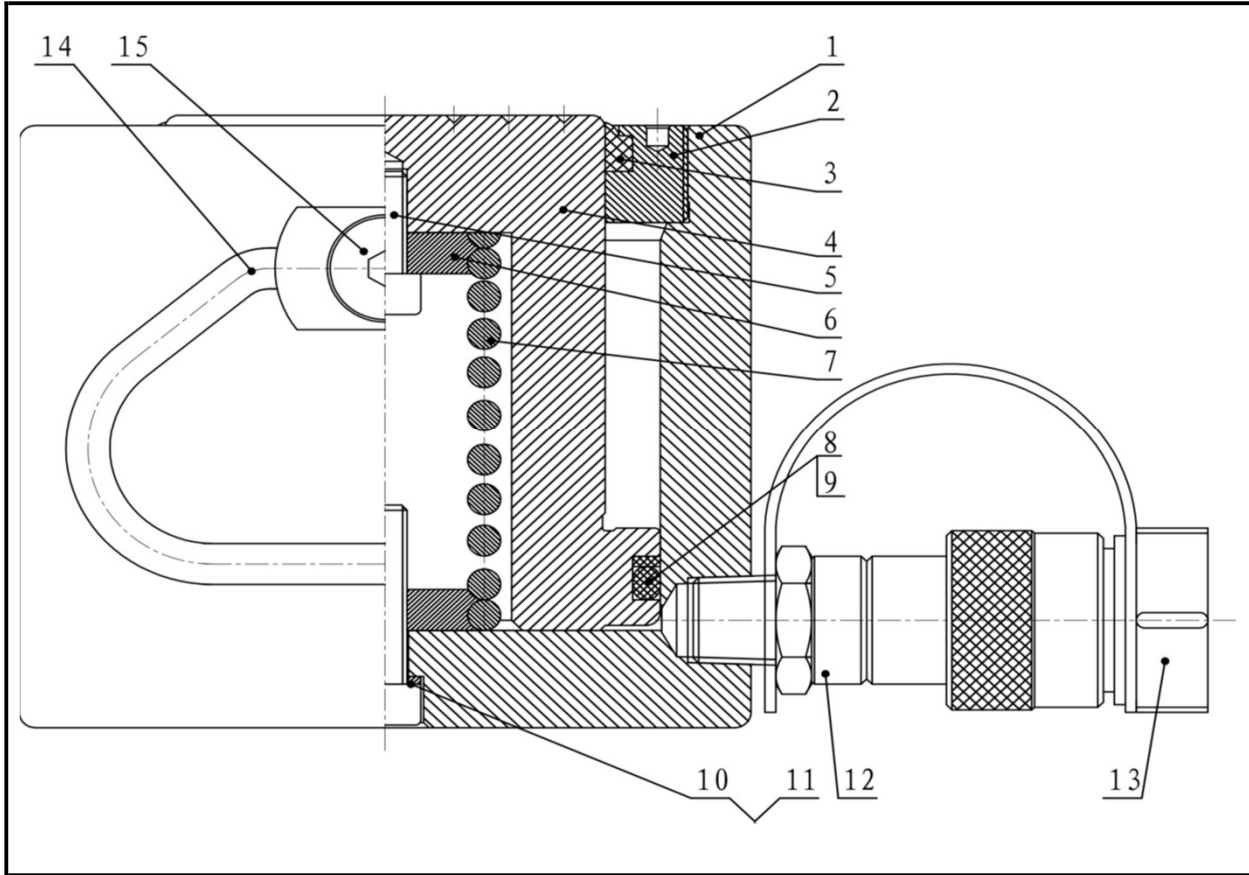

Item NO.	Description	Qty	Part NO.
			SLC20-45
1	Oil cylinder	1	2.001.00292
2	Guide cap	1	2.001.00054
3	J-dustband	1	●
4	Piston rod	1	2.001.00171
5	Hexagon socket head cap screws	1	●
6	Spring connecting head	2	-
7	Returning spring (Item #6 included)	1	1.3.011.00006
8	Backup Washer	1	●
9	O - ring	1	●
10	Copper gasket	1	●
11	Hexagon socket head cap screws	1	●
12	Female connector	1	1.3.025.00004
13	Connector protective jacket for NPT3/8"	1	1.3.097.00002
●	Repair kit	1	SLC20-RK