

Double-Acting High Tonnage Cylinders - DRC series

Doc. : L1016A Date : 2018/12

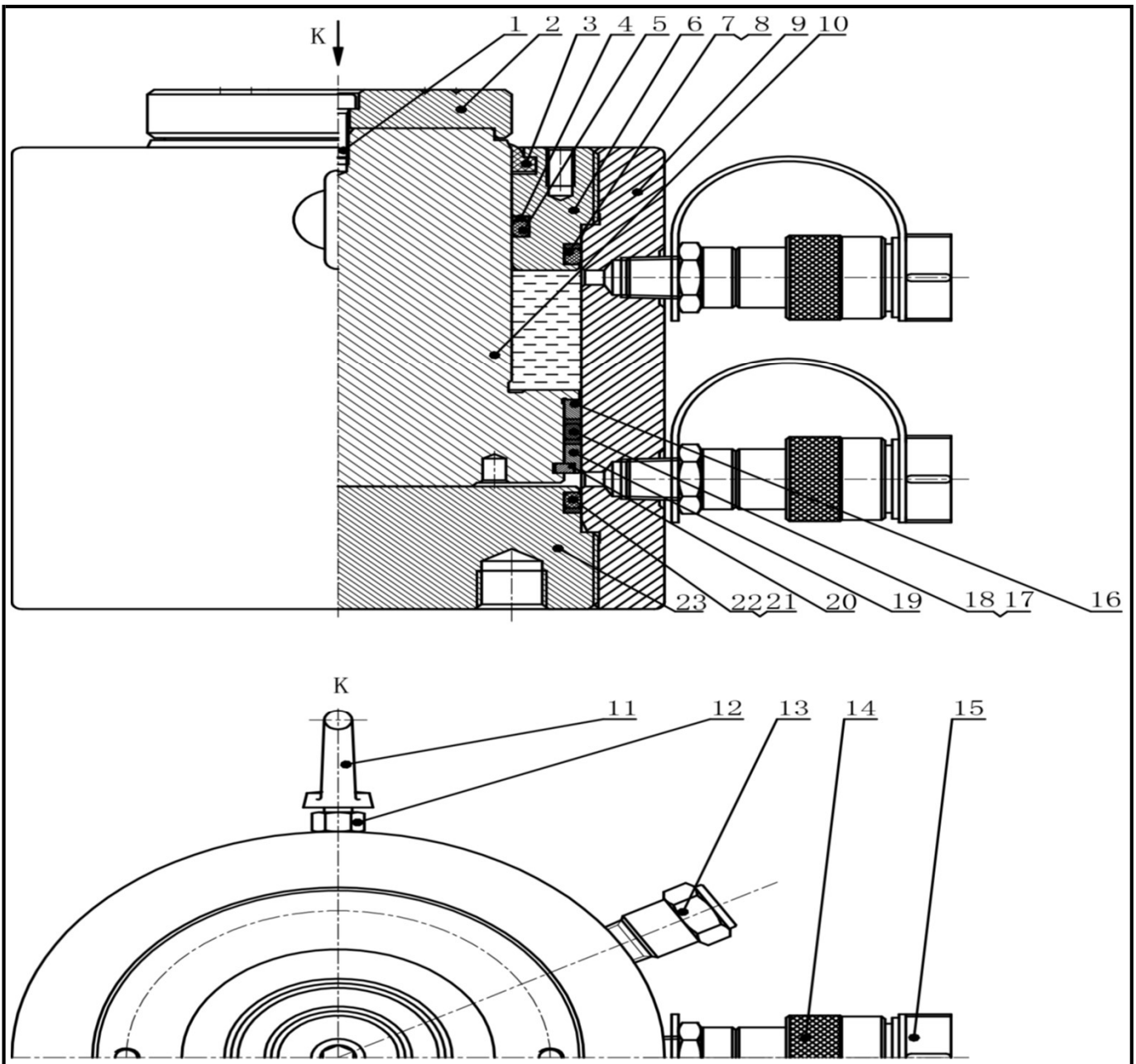

Item NO.	Description	Qty	Part NO.		
			DRC400-100	DRC400-200	DRC400-300
1	Hexagon socket head cap screws	1		•	
2	Lifting head	1		2.001.02750	
3	J-dustband	1		•	
4	Backup washer	1		•	
5	O-ring	1		•	
6	Guide cap	1		2.001.02751	
7	Backup washer	1		•	
8	O-ring	1		•	
9	Oil cylinder	1		2.001.02759 (DRC400-100)	
		1		2.001.02752 (DRC400-200)	
		1		2.001.02761 (DRC400-300)	
10	Piston rod	1		2.001.02760 (DRC400-100)	
		1		2.001.02753 (DRC400-200)	
		1		2.001.02762 (DRC400-300)	
11	Lifting bolt (Item #12 included)	2		1.3.009.00002	
12	Hexagon nut	2		-	
13	Safety valve	1		2.008.00047	
14	Female connector	2		1.3.025.00004	
15	Connector protective jacket for NPT3/8"	2		1.3.097.00002	
16	Front guide sleeve	1		2.001.02755	
17	Backup washer	2		•	
18	O-ring	1		•	
19	Back guide sleeve	1		2.001.02756	
20	Semi-ring	1		2.001.02757	
21	Backup washer	1		•	
22	O-ring	1		•	
23	Bottom cap	1		2.001.02758	
•	Repair kit	1		DRC400-RK	